

Review

## SPECIAL DEVICES FOR REGIONAL ANAESTHESIA

Edgars Vasiļevskis\*, Aleksejs Miščuks\*\*, and Indulis Vanags\*

\* Rīga Stradiņš University, Dzirciema iela 16, Rīga, LV-1007, LATVIA

\*\* Latvian Orthopaedic and Traumatology Hospital, Dunties iela 22, Rīga, LV-1005, LATVIA  
E-mail: edgars.vasilevskis@inbox.lv

Communicated by Rafails Rozentāls

*The rapid growth of regional anaesthesia in the last 20 years has resulted in an increasing number of technical devices. Technical resources play a very considerable role in modern regional anaesthesia and they are being introduced to facilitate the quality performance of this type of anaesthesia. The task of this survey is to summarise the most important technical devices currently utilised for regional anaesthesia and to provide a review of the history of their introduction. Technical devices for performing regional anaesthesia could be divided in seven groups: 1) neurostimulation and simple needles and catheters; 2) neurostimulator with transcutaneous nerve stimulation (TENS); 3) ultrasonograph with a device to fix the probe; 4) devices for injection of local anaesthetics, such as perfusors, patient controlled analgesia systems and elastomeric infusion systems; 5) arm, leg and instruments supports; 6) regional anaesthesia injection monitor and data register devices, and 7) catheter fastenings and auxiliary materials. It is recommended that all of the apparatus applied should be classified to make it easier to acquire more immediate and understanding, and be easy to add this knowledge to the overall checklist before starting anaesthesia. The history of the introduction of technical equipment shows how much time was necessary for the development of modern regional anaesthesia methods.*

**Key words:** regional anaesthesia, local anaesthetic, neurostimulation, ultrasonography.

### INTRODUCTION

As a result of the rapid growth of regional anaesthesia (RA), an increasing number of technical devices are being introduced to facilitate the quality performance of RA. The task of this survey is to classify the most important technical devices currently utilised for RA and to review the history of their introduction.

Way back in 1884, Austrian ophthalmologist, Carl Keller defined the properties of cocaine as a local anaesthetic and was the first person to begin using it for topical anaesthesia during eye surgery. Not long afterwards, William Halsted and John Hall tested peripheral nerve blocks (Halsted, 1885; Hall, 1884). Subsequently, there was a rapid development in all techniques that enabled the suspension or a delay in the transmission of a nervous impulse along peripheral nerves without having any impact on the brain.

The subsequent development of RA to the present level has depended to a considerable degree on technical progress and the invention of various technical devices.

Initially, RA was carried out solely utilising a needle and syringe for the injection of a local anaesthetic (LA) into the immediate vicinity of nerves or their plexuses.

Subsequent breakthroughs in the improvement of equipment and quality were: discovery of the principle of neurostimulation, introduction of technical equipment for the long-lasting injection of an anaesthetic (initially with a fixed needle, later with a catheter) and the application of ultrasonography for localisation of nerves.

Comparatively recently, several inventions have improved the quality of an anaesthesiologist's work ensuring a comfortable position for both the patient and doctor during the entire time of the performance of RA: hand and foot supports that are specifically provided for the performance of RA and the control of an autonomous stimulator by foot, in order to ensure that an anaesthesiologist can use his hands freely during the process of manipulation.

Several of these innovations have been combined in a joint "regional anaesthesia station" (Injectobloc) which incorporates a neurostimulator controlled by foot, hand and foot supports for the positioning of a patient, an ultrasonograph for localisation of nerves and shelves for the arrangement of instruments.

The entirety of the aforementioned development open up new and previously unheard of opportunities in the provision of RA.

It is recommended that all of the apparatus applied should be classified to make it easier to acquire more immediate and comprehensive understanding to simplify addition to the overall checklist that is necessary to check before starting anaesthesia.

## TECHNICAL DEVICES FOR PERFORMING REGIONAL ANAESTHESIA

### Needles and catheters

- Needles without neurostimulation
- Neurostimulation needles (today all the commercial needles are the insulated ones)
- Catheters
- Stimulating catheters

### Neurostimulator. TENS

Ultrasonography. Device to fix the probe

### Devices for LA injection

- Perfusors
- Patient-controlled analgesia (PCA)
- Elastomeric infusion systems

### Supports

- Arm
- Leg
- Pillows and cushioned supports

### RA performance monitoring and data register devices

- Pressure monitor
- Current intensity monitor
- Data register of RA parameters (stimulation intensity, injection time, pressure and LA volume)

### Fastenings and auxiliary materials

## Needles and catheters

**Needles.** One of the most important technical attributes during the course of RA is a puncture needle. Originally, ordinary injection needles were used for this purpose, but as the requirements for RA equipment grew, needles were specially adapted.

During the formative stage of RA around 1886, Heinrich Iraneus Quincke began applying the method of lumbal puncture with cutting lancet form needles which are still named after him and are characterised by a truncated, cutting tip which penetrates tissue easily including in dense in-

terspinal ligaments (Quincke, 1891). However, an alternative needle with a so-called "pencil-point" form was already patented in 1888 whose advantage was the non-traumatic separation of tissue and which did not leave a broad channel after puncture for which closure and healing were difficult (Alleman, 1886) (Fig. 1).

(No Model.)

J. J. ALLEMAN.  
BLOATING NEEDLE.

No. 387,480.

Patented Aug. 7, 1888.

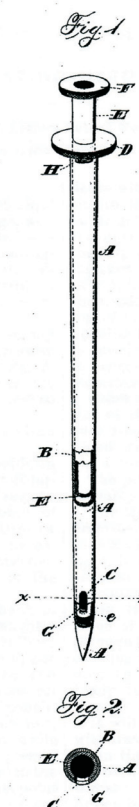

Witnesses:  
Chas. J. Williamson,  
Henry C. Hazard

Inventor:  
J. J. Alleman,  
by Birrell & Russell,  
his Attorneys.

H. PETERS, Photo-Lithographer, Washington, D. C.

Fig. 1. Alleman J.J. (1888). Bloating-needle. United States Patent No. 387480.

RA needles without neurostimulation may be utilised for individual techniques during the course of which isolated, sensitive nerves are blocked. This applies, for example, to the iliofascial block, *n. dorsalis penis* or intercostal nerve blocks. The same applies to perimedullar anaesthesia—spinal and epidural puncture.

In contrast, special needles which enable the supply of current impulses are utilised for all techniques requiring neurostimulation.

Needles are divided according to their length, diameter, angle of the tip and whether they are insulated or not. The main models of needles are Quincke with Pitkin and Green modifications, Pencil-point with Sprotte and Whitacre modifications and Touhy or Hustead needles (for epidural anaesthesia) (Fig. 2).

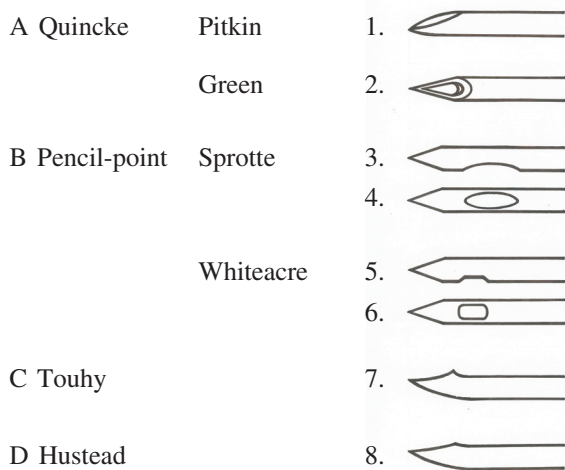

Fig. 2. The more often used needles for regional anaesthesia.

A special needle for combined epidural and spinal anaesthesia was patented in 1983 by John M. Evans (Evans, 1983).

Originally, stimulating needles conducted current along the entire surface of the needle. In 1969, Wright and Koons tested insulated needles in which current only reached the tip of the needle, which ensures high current density at the tip of the needle and precise placement of the needle close to nerves.

In 1980, Galindo was the first to describe the requirements necessary for nerve stimulation needles more precisely (Galindo, 1980).

Even though nerve stimulation can be carried out with needles of both types, it was discovered that insulated needles significantly increase quality and reduce the risk of complications (Ford *et al.*, 1984).

For most single-shot peripheral nerve blocks 21–25 gauge, short bevel insulated needles are used. The reason for this is the high current density at the tip of the needle which is extremely effective in causing muscle response.

For continuous blocks, a Touhy tip needle with an ordinary or stimulating catheter is used.

**Catheters.** The main function of catheters is the prolonged injection of medicines or anaesthetic into the intended spot without repeating puncture. Originally, this role in neuroaxial and peripheral nerves anaesthesia was played by the same puncture needles, which depending on the fantasy and imagination of the author was consolidated in the puncture spot.

The first data are given in regard to prolonged spinal anaesthetics.

In 1940, William Lemmon commenced a prolonged spinal anaesthesia by initially carrying out the puncture in a lateral position, and, then keeping the needle intrathecally, the patient was turned onto his back and repeated injections were carried out through an opening in the table (Lemmon, 1940).

In 1942, Waldo Edwards and Robert Hingson commenced prolonged caudal anaesthesia during childbirth utilising the Lemmon needle described above. In 1944, Edward Touhy developed his now globally renowned Touhy needle for the insertion of a silk urethral catheter spinally, which later was modified by Huber and Curbelo for the insertion of catheters epidurally (Touhy, 1944; Curbelo, 1949).

Likewise, peripheral nerve blocks developed.

In 1946, Ansbro adapted an injection needle for supraclavicular nerve block and fixed it using a cork for the repeated injections of LA (Ansbro, 1946).

In 1951, S.J. Sarnoff and L.C. Sarnoff were the first to use a plastic catheter for *nervus phrenicus* block patients with prolonged hiccups (Sarnoff *et al.*, 1951).

The next soft catheters specially adapted for prior placement onto the needle only entered service two decades ago, through the work of DeKrey and Winnie in 1969 and 1970 in order to ensure the perivascular and axillar extension of plexus brachial block (DeKrey *et al.*, 1969; Winnie, 1970).

Later on, from 1978, Callahan and other authors began to use epidural catheters already in use that were easy to insert for this purpose (Brands and Callan, 1978).

After 1990, when nerve blocks were becoming even more popular, specialists attempted to create specially adapted devices for peripheral nerve blocks from peripheral vein, spinal or epidural punctures, technical equipment through an initial combination of existing models until manufacturers changed the needles and catheters for use with a stimulator.

Regarding materials from which catheters are produced, the first silk urethral catheters were replaced by polyethylene in 1949 and not long afterwards by polyvinylchloride catheters, which could be sterilised more effectively at high temperatures without deforming them. The latest slim catheters are manufactured from Teflon, polyurethane and silicon, which are thin, kink resistant catheters with the requisite stiffness and tensile strength (Ates *et al.*, 2000).

The most important innovation in recent years is the stimulating catheter which enables repeated control of the position of the catheter tip following removal of the stimulation needle, thus guaranteeing successful RA throughout the course of the injection of the anaesthetic. These are used for both peripheral nerve and epidural anaesthetics. The publication regarding the use of such catheters appeared in 1998

when Sutherland adapted the urethral catheter with a metal stilet for a nervus ischiadicus prolonged block (Sutherland, 1998). Thereafter, other authors also adapted existing catheters until manufacturers commenced production of special stimulating catheters.

Today, such catheters are offered by several manufacturers, for example, Multiplex (Vygon), Stimulong and Stimulong Tsui (Pajunk) and Stimucath (Arrow). However, at present there are still not enough clinical studies that prove the safety of these stimulating catheters and provide a comparison with standard non-stimulating catheters.

### Neurostimulator

Prior to the discovery of the principle of neurostimulation (NS) and its introduction in practice, all RA techniques were based on the principle of paresthesia and outstanding knowledge of the topographical anatomy.

Neurostimulation may appear to be a comparatively recent method, but it transpires that it was used for the first time as early as 1912.

The earliest apparatus only ensured constant voltage, with variable current output due to varied resistances in the different tissues. Now, with the advances in technology, most modern models deliver a constant current and the current output can be set in frequency, pulse width and current miliamperes (mA).

Neurostimulation was first described by the German surgeon, Georg von Perthes (Perthes, 1912). He utilised a nickel needle that was enamel plated and connected to an electric current. Positioning the needle, the current caused muscular contractions. This method was an improvement compared to the Kuhlenkampff supraclavicular block used back in those days which only utilised the method of paresthesia. However, the apparatus was too large and not particularly accurate and therefore the method was discarded and forgotten for a long time. In the 1920's, Strohl improved the stimulator and created a device named the "Egersimetre", the first mobile stimulator. However, even these improvements were not sufficient for the method to develop rapidly (Pandin, 2006).

A genuine mobile neurostimulator with variable current intensity only appeared in 1962, due to the work of Greenblatt and Denson (Greenblatt and Denson, 1962).

Thereafter, several authors applied their patents for the improvement of the stimulator.

In 1969, John E. Colyer offered a hypodermic needle with two electrodes with which to conduct the current from an external battery, thus carrying out neurostimulation (Colyer, 1969) (Fig. 3).

In 1970, Richard Norman Naylor went a step further and offered a mobile, autonomously powered device for the localisation of nerves (Naylor, 1970) (Fig. 4).

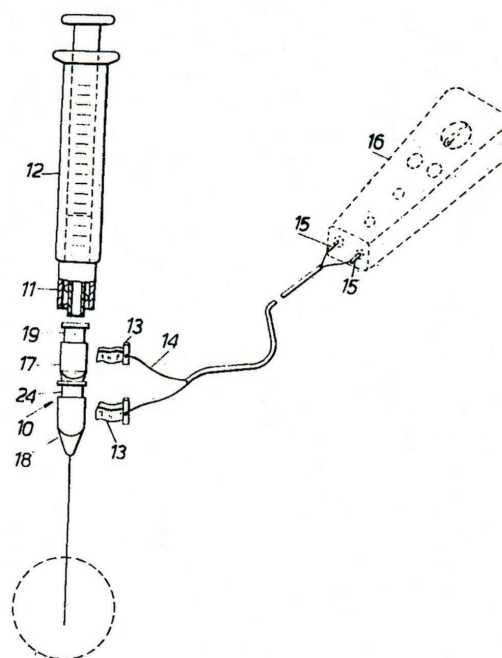

Fig. 3. Colyer, J.E. (1972). Combined electrode and hypodermic syringe needle. United States Patent No. 3682162.

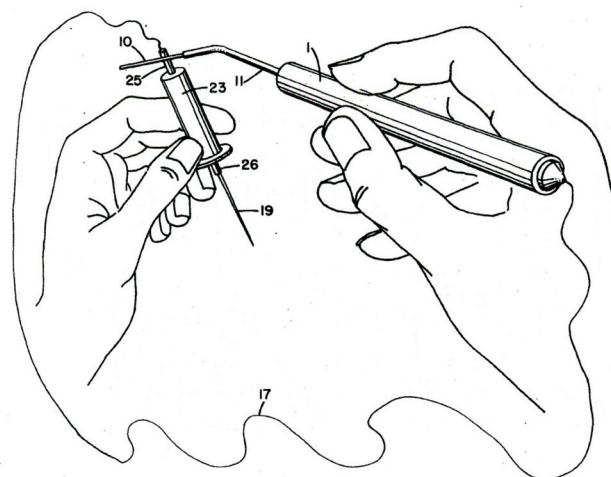

Fig. 4. Naylor, R.N. (1972). Nerve Locator / stimulator. United States Patent No. 3664329.

The first publication on the use of the modern stimulator were provided by Montgomery and Raj in 1973 (Montgomery *et al.*, 1973).

In 1983 and 1985, Galindo, Ford, Pither and Raj shared their experience of that period to define the main principles for contemporary electrostimulation and conditions for neurostimulation needles (Galindo, 1983; Pither *et al.*, 1985).

In 1978, Curtis Miller and Mark Kaldun patented the principle of modern peripheral nerve stimulator and neuromuscular block monitor. It must be pointed out that even the patent drawing is only slightly different to the neuromuscular block stimulators in use today, because they still include the principle parameters of: "twitch", "train of four" and "teta-



nus” stimulation and variable amplitude and frequency. The peripheral nerve stimulation drawing from this patent has become a classic (Miller *et al.*, 1978) (Fig. 5).

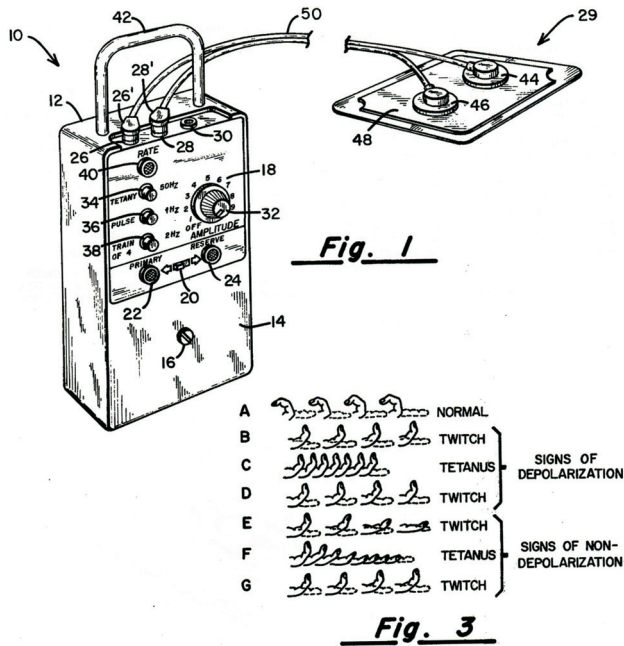

Fig. 5. Miller, C.H., Kaldun, M.R. (1979). Peripheral nerve stimulator. United States Patent No. 4157087.

In 1983, Martin Chester and Cary Norman patented the principle of the modern neurostimulator with an anode and cathode as two electrodes, an autonomous source of energy, impulse chain and variable amplitude. This innovation allowed the direct placement of this device on the injection needle (Chester and Cary, 1983). Today, however, the stimulator is a separate device which is connected to the needle by a cable (Fig. 6).

Thereafter, stimulators were continually improved even though there were less significant new developments. One such improvement was transcutaneous nerve stimulation (TENS) or “nerve mapping” which was initially used as a method for nerve therapeutical stimulation. This enables transcutaneous nerve or nerve plexus localisation prior to puncture and was mentioned for the first time by Roizen (1993) in establishing an interscalenus block

There was also improvement of the doctor’s comfort level when working with the stimulator. In 1997, French author, Dr. Francois Biechler patented a stimulator controlled by foot which has the additional function of a perfuser and pressure monitor (Biechler, 1997). Later, this idea together with the improvement of the patient’s position and opportu-

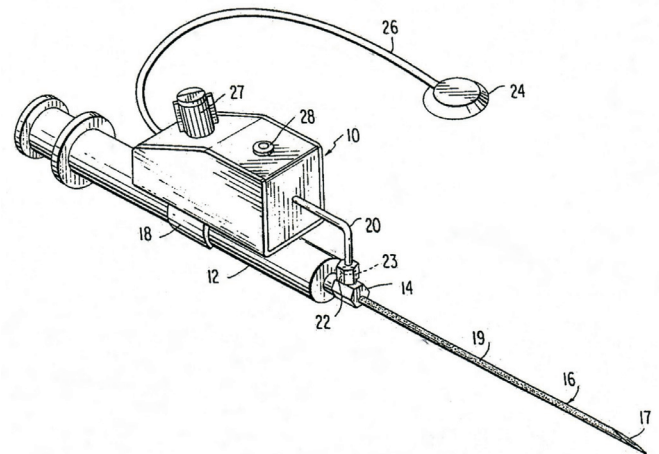

Fig. 6. Chester M., Cary N. (1985). Clamp-on Nerve Stimulator and locator. United States Patent No. 4515168.

nities for the placement of the material provided the basis of the “Injectobloc” regional anaesthesia station (“Locoflex 4”, 2007) (Fig. 7).



Fig. 7. Biechler F. (1997). Injectobloc, Brevet d’Invention en France Nr. 06 3 422 020 (with permission of Vygon Ltd).

American authors had similar ideas and they were responsible for patenting an isolated change in the amplitude of the stimulator with a pedal or an integrated control button located under the sterile surgical glove (Hadzic and Vloka, 1997).

### Ultrasonograph

Ultrasonography (US), originally only a diagnostic method, is currently being actively applied during the course of anaesthesia manipulations. In 1984, the first central vein catheterisation under US control took place. During the 1990’s production of special probes for the catheterisation of veins was commenced. Nowadays, US is available in the form of mobile transportable apparatus. The first such mobile apparatus was patented in the year 2000 (Koester *et al.*, 2000) (Fig. 8).

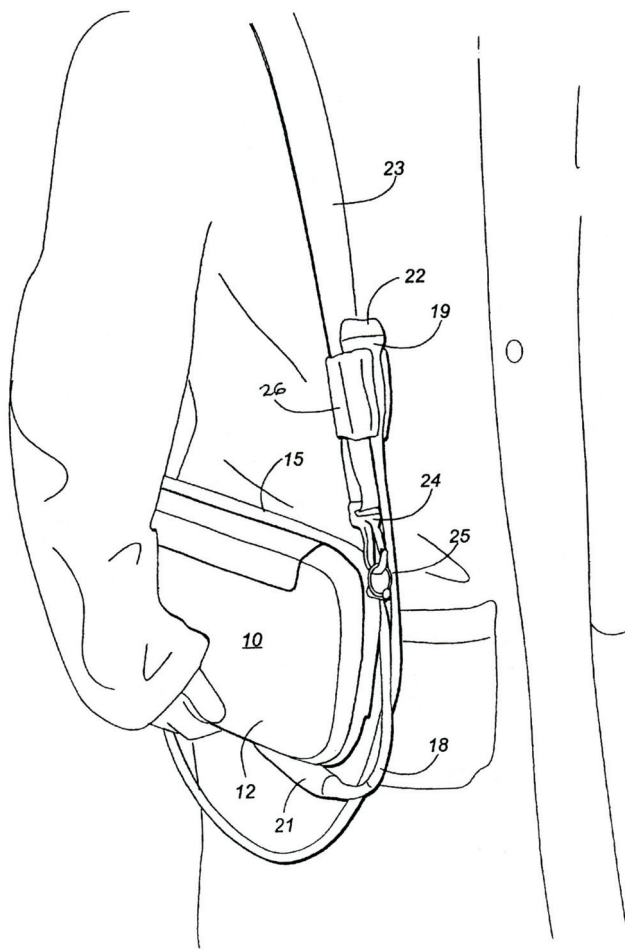

Fig. 8. Rhoad, P.K., Parnagian, E.C., Barracloug, S., Douglas E., Hariott, J.M., Blackwell-Jones (2003). Ultrasound diagnostic device. United States patent No. 6540685.

The first publication on the application of US for peripheral nerve blocks dates back to 1978. However, in recent years in particular, the number of publications in this area of anaesthesiology is growing exponentially (Grange, 1978). Currently, portable US apparatus are utilised for peripheral blocks with a Doppler function applying 5–10 MHz linear probes. The US apparatus used most frequently in Europe are: “I-Look”, “Titan”, “Micromaxx” (Sonosite), “Logiq e” (General Electric) and “Esaote” (Kontron).

### Systems for LA injection

The application of RA with a catheter requires an apparatus that ensures LA injection over a shorter or longer period of time. The application of standard perfusors, patient-controlled analgesia (PCA) or elastomeric infusion systems is possible.

Standard perfusors have been replaced by more modern apparatuses, because, in continuing RA, perfusors occupy a lot of space, encumber the mobility of patients around the ward or department and in comparative terms provide a lower level of safety.

PCA systems enable the patient himself to regulate the speed of the injection of LA or other medicines depending on the level of pain, whilst observing the injection interval and maximum dose within a unit of time as specified by the doctor.

Elastomer systems that are filled with LA in advance and later emptied as a result of the constant narrowing of elastic membranes at the selected speed are even more progressive. They can be improved through the connection of an additional PCA function. One of the first innovations of this type was patented in 1999 (Keiichi *et al.*, 2001).

Currently, the most popular models available on the market are: Easypump (Braun), Baloonjector (Daiken Medical), In-fusor (Baxter) etc.

### Supports

Manipulation of regional anaesthesia requires a lot of concentration and accuracy on the part of the anaesthesiologist. The stationary position of the patient during the course of RA is also of vital importance, because the placement of the tip of the needle next to the nerve must be carried out to an accuracy of a few millimetres.

During a survey carried out in 2007, as a means of studying possible ways of positioning the patient, it turned out that depending on the provision of the operation block, an extremely diverse range of materials were used to establish the position of the patient: hand and foot supports, pillows, cushioned supports or the extremity was held by the nurse or the assistant (Vasilevskis *et al.*, 2007).

The hand and foot supports attached to the operation table are used most frequently and have been known for a long time, but autonomous supports during the performance of a procedure right next to the patient’s bed or on located on a trolley that can be pushed and whose use is integral to the daily work of an anaesthesiologist have been available only rarely. Several patents have been submitted by Latvian authors with a view to resolving this problem (Vasiļevskis *et al.*, 2004; 2005; 2006; 2007) and these patents open a new sub-group in the international patent classification. “Devices for loco-regional anaesthesia” now supplement the section, “Devices for upper extremity operations”. The aforementioned patents are modifications of the device that is provided for the positioning of the patient’s hands and feet during the course of RA. A “regional anaesthesia station” has also been created together with a group of French colleagues, which includes support for the positioning of hands and feet, a mobile shelf for the placement of the neurostimulator, as well as a shelf for the placement of an ultrasonograph or instruments. This station optimises the doctor’s manipulation by enabling the stationary positioning of the patient and placement of all of the necessary apparatus within the work area. The universal frame “Locoflex 4E” is the platform for this station on which the aforementioned apparatus is placed, as well as the hand or foot supports (“Locoflex 4”, 2007) (Fig. 9).



Fig. 9. "Locoflex 4". (2007) In Latvia medical device registered by the EU; with permission of „Locoflex” Ltd.

### RA performance monitoring and data register devices

Several technical improvements increasing the safety of RA are also worthy of mention.

Hadzic and Vloka (2004) patented a device that is utilised for constant pressure control during the course of the injection of LA. It provides a warning of an uncontrolled increase in pressure during the course of injection of LA over 20 psi which is most frequently because of intraneural needle position and potential nerve damage.

A similar function is incorporated within the combined stimulator and perfuser in the "Injectobloc" model. Here, the injection of LA is carried out with a perfuser and the injection is suspended when specific pressure limit 20 psi exceeds 1.4 Bar, (Biechler, 1997).

Another improvement makes control of the intensity of current impulse during RA easier. This factor can also provide

a warning about the intraneural position of the needle in cases when the impulse, weaker than 0.1 mA, is still causing stimulation of the peripheral motor nerve with the contraction of the muscle. The device divides amplitude of the impulse into three groups and applies a signal lamp of a different colour for each. This curtails the injection of LA when the specified minimal limit is exceeded.

Another important innovation available for the first time in the aforementioned "Injectobloc" is the opportunity to register and save all data regarding RA manipulation: stimulation limit, injection time and pressure and the volume of the medicine injected. This opens up new opportunities for a safer and higher quality performance of RA and reducing the risk of possible complications.

### Fastenings and auxiliary materials

In order to make work easier and to ensure asepsia, pre-prepared sterile sets are available to the anaesthesiologist, which include a selection of puncture or stimulation needles, sterile compresses, covering sheets, gloves etc. Various types of adhesive fastenings also constitute a major step forward, which make it possible to hold the catheter which remains *in situ* for 24–72 hours. When this period of time passes, catheters can be tunnelised, that is, moved subcutaneously 5–15 cm from the nerve location spot and then to lead it out, to ensure asepsia during the treatment of the catheter and in order to reduce the risk of infections.

### CONCLUSION

The history of the introduction of technical equipment shows how much time was necessary to invest to arrive at the quality of modern RA methods. Technical resources play a very considerable role in today's RA.

### REFERENCES

- Anonīms (2007). LR Veselības ministrijas apliecība Nr. 070514 par CE marķētas medicīnas ierīces "Locoflex 4" fiksatora lokoreģionālai anestēzijai iekļaušanu medicīnas ierīču reģistrā LATMED, Nr. 0549000000, 14.09.2007 [Registration of "Locoflex 4" in Latvian register of medical devices] (in Latvian).
- Ansbro, F.P. (1946). A method of continuous brachial plexus block. *Amer. J. Surg.*, **71**, 716–722.
- Ates, Y., Yucesoy, C.A., Unlu, M.A., Saygin, B., Akkas, N. (2000). The mechanical properties of intact and traumatized epidural catheters. *Anesth. Analg.*, **90**, 393–399.
- Alleman, J.J. (1886). Bloating-needle, United States Patent No. 387480, filed August 26, 1886.
- Biechler, F. (1997). Injectobloc, Brevet d'Invention en France No. 06 3 422 020 du 05.12.1997.
- Brands, E., Callanan, V.L. (1978). Continuous lumbar plexus block: analgesia for femoral neck fractures. *Anaesth. Intensive Care*, **6**(3), 256–258.
- Chester, M., Cary, N. (1983). Clamp-on Nerve Stimulator and Locator, United States Patent No. 4515168, filed Jul. 22, 1983.
- Colyer, J.E. (1969). Combined electrode and hypodermic syringe needle; United States Patent No. 3682162, filed Dec. 4, 1969.



- Curbelo, M.M. (1949). Continuous peridural segmental anesthesia by means of ureteral catheter. *Curr. Res. Anesth. Analg.*, **28**, 181–189.
- Dekrey, J.A., Schroeder, C.F., Buechel, D.R. (1969). Continuous brachial plexus block. *Anesthesiology*, **30**, 332.
- Evans, J.M. (1983). Instrument and method for epidural and spinal anesthesia, United States Patent No. 4518383, filed August 2, 1983.
- Ford, D.J., Pither, C., Raj, P.P. (1984). Comparison of insulated and not insulated needles for locating peripheral nerves with a peripheral nerve stimulator. *Anesth. Analgesia.*, **63**(10), 925–928.
- Galindo, A. (1980). Special needle for nerve blocks. *Ref. Anaesth.*, **4**, 12.
- Galindo, A. (1983). Electrical localization of peripheral nerves: instrumentation and clinical experience. *Regional Anesthesia*, **8**, 49–50.
- Greenblatt, G., Denson, J. (1962). Needle nerve block locator. *Anesth. Analg.*, **41**, 599–602.
- Hadzic, A., Vloka, J. (1997). Apparatus for locating and anesthetizing peripheral nerves a method therefore, United States Patent Nr: 5830151, filed Nov 26, 1997.
- Hadzic, A., Vloka, J.D. (2004). Method and apparatus to decrease the risk of intraneuronal injection during administration of nerve block anesthesia, United States Patent No. US 2005/0043710 A1, filed Sep. 28, 2004.
- Hall, R.J. (1884). Hydrochlorate of cocaine. *NY Med. J.*, **40**, 643.
- Halsted, W.S. (1885). Practical comments on the use and abuse of cocaine; suggested by its invariably successful employment in more than a thousand minor surgical operations. *NY Med J.*, **42**, 294.
- Keiichi Yamada, Mitsuyoshi Inoue, Hajime Nakazawa, Atsushi Yamamoto, Tatsuji Higashi. (2001). Liquid discharge regulator and liquid feeder equipped with the same, United States Patent No. 6270483, filed Aug. 7, 2001.
- La Grange, P., Foster, P., Pretorius, L. (1978). Application of Doppler ultrasound blood flow detector in supraclavicular brachial plexus block. *Brit. J. Anaesth.*, **50**, 965–967.
- Lemmon, W.T. (1940). A method of continuous spinal anaesthesia. *Ann. Surg.*, **111**, 141–144.
- Miller, C.H., Kaldun, M.R. (1978). Peripheral nerve stimulator, United States Patent No. 4157087, filed Mar. 6, 1978.
- Montgomery, S.J., Raj, P.P., Nettles, D., Jenkins, M.T. (1973). The use of the nerve stimulator with standard unsheathed needles in nerve blockade. *Anesth. Analg.*, **52** (5), 827–831.
- Naylor, R.N. (1970). Nerve Locator / stimulator, United States Patent No. 3664329, filed Mar. 9, 1970.
- Pandin, P. (2006). *Précis interactif d'anesthésie loco-régional*. Sauramps Medical. 315 pp.
- Pither, C.E., Raj, P.P., Ford, D.J. (1985). The use of peripheral nerve stimulators for regional anesthesia: A review of experimental characteristics. *Reg. Anesth.*, **10**, 49–58.
- Rhoads, P.K., Parnagian E.C., Barraclough, S., Douglas, E., Harriott, J.M., Blackwell-Jones. (2000). Ultrasound diagnostic device, United States patent No. 6540685, filed Nov. 9, 2000.
- Quincke, H. (1891). Die Lumbalpunktion des Hydrocephalus. *Klin. Wochenschr.*, **28**, 929.
- Roizen, M. (1993). Use of Transcutaneous Nerve stimulation to assist interscalene block. *Anesthesia Analgesia*, **76**, 902–920.
- Sarnoff, S.J., Sarnoff, L.C. (1951). Prolonged peripheral nerve block by means of indwelling plastic catheter treatment of hiccup. *Anesthesiology*, **12**(3), 270–275.
- Sutherland, I.D. (1998). Continuous sciatic nerve infusion: Expanded case report describing a new approach. *Reg. Anesth. Pain Med.*, **23**, 496–501.
- Touhy, E.B. (1944). Continuous spinal anaesthesia: its usefulness and technique involved. *Anesthesiology*, **5**, 142–148.
- Vasiļevskis, E., Miščuks, A., Vanags, I. (2007) Reģionālās anestēzijas efektivitāti ietekmējošo faktoru analīze [Analysis of different factors influencing the success of regional anaesthesia]. Grām. *RSU Zinātniskie raksti*. RSU: Rīga, 111.–117. lpp. (in Latvian).
- Vasiļevskis, E., Vanags, I. (2004). Ierīce augšējās ekstremitātes operācijām [Device for surgery of upper extremity]. Patents Nr. 13204 no 26.05.2004. Patenti un preču zīmes, 2004/11–20.11.2004, 1656 (in Latvian).
- Vasiļevskis, E., Vasilevskis, L. (2004). Ierīce lokoreģionālajai anestēzijai [Device for locoregional anaesthesia], patents Nr. 13224 no 20.12.2004 (in Latvian).
- Vasiļevskis, E. (2005). Ierīce lokoreģionālajai anestēzijai [Device for locoregional anaesthesia], patents No. 133375 no 20.08.2005 (in Latvian).
- Vasiļevskis, E. (2006). Ierīce lokoreģionālajai anestēzijai (Device for locoregional anaesthesia), Latvijas Republikas patentu valde, 2008. 2006, patents LV 13375 B (in Latvian).
- Vasiļevskis, E., Ramanis, M. (2007). Ierīce lokoreģionālajai anestēzijai [Device for locoregional anaesthesia], Latvijas Republikas patentu valde, 20.05.2007, patents LV 13563 A. (in Latvian).
- Von Perthes, G. (1912). Über Leitungsanaesthesie unter Zuhilfenahme elektrischer Reizung. *M. Med. Wochenschr.*, **22**, 2545–2548.
- Winnie, A.P. (1970) Interscalene brachial plexus block. *Anesth. Analg.*, **49**, 455–466.

Received 18 August 2008

## TEHNISKĀS IERĪCES REĢIONĀLĀS ANESTĒZIJAS VEIKŠANAI

Sakarā ar straujo reģionālās anestēzijas attīstību tiek ieviests aizvien vairāk tehnisko ierīču anestēzijas kvalitatīvai izpildei. Apskata mērķis ir sagrupēt svarīgākās tehniskās ierīces un izgudrojumus (patentus) un aplūkot to ieviešanas vēsturi. Iepriekš minētās ierīces varētu iedalīt septiņās galvenajās grupās: 1) neirostimulācijas adatas un katetri; 2) neirostimulators ar transkutāno nervu stimulāciju; 3) ultrasonogrāfs ar zondēm un palīgierīcēm; 4) aparātūra lokālā anestētiķa ievadei kā perfuzori, pacienta kontrolētās analģēzijas un elastomēru infūzijas sistēmas; 5) roku un kāju atbalsti; 6) reģionālās anestēzijas veikšanas monitoringa un datu reģistra ierīces; 7) dažādi stiprinājumi un palīgierīces. Šādas klasifikācijas ieviešana būtu iesakāma aparātūras pārbaudes sistematizēšanai, gatavojoties anestēzijai.